



Наличие и актуальные цены на

DRT-960-24

<https://www.mean-well.ru/store/DRT-960-24/>



■ Features :

- Three-Phase AC 340 ~ 550V wide range input
- High efficiency 91% and low dissipation
- Protections: Short circuit / Overload / Over voltage / Over temperature
- Optional parallel function(1+1)
- Cooling by free air convection
- Can be installed on DIN rail TS-35/7.5 or 15
- UL 508(industrial control equipment)approved
- EN61000-6-2(EN50082-2) industrial immunity level
- 100% full load burn-in test
- 3 years warranty



SPECIFICATION

MODEL	DRT-960-24	DRT-960-48	
OUTPUT	DC VOLTAGE	24V	48V
	RATED CURRENT	40A	20A
	CURRENT RANGE	0 ~ 40A	0 ~ 20A
	RATED POWER	960W	960W
	RIPPLE & NOISE (max.) Note.2	80mVp-p	80mVp-p
	VOLTAGE ADJ. RANGE	24 ~ 28V	48 ~ 55V
	VOLTAGE TOLERANCE Note.3	±1.0%	±1.0%
	LINE REGULATION	±0.5%	±0.5%
	LOAD REGULATION	±0.5%	±0.5%
	SETUP, RISE TIME	200ms, 60ms/400VAC	200ms, 60ms/500VAC at full load
HOLD UP TIME (Typ.)	14ms/400VAC	30ms/500VAC at full load	
INPUT	VOLTAGE RANGE	Three-Phase 340 ~ 550VAC (Dual phase operation possible in connecting L1,L3,FG Note.5)	
	FREQUENCY RANGE	47 ~ 63Hz	
	EFFICIENCY (Typ.)	91%	92%
	AC CURRENT (Typ.)	2A/400VAC	1.6A/500VAC
	INRUSH CURRENT (max.)	COLD START 50A	
	LEAKAGE CURRENT	<3.5mA / 530VAC	
PROTECTION	OVERLOAD	105 ~ 125% rated output power Protection type : Constant current limiting, unit will shut down o/p voltage after 3 sec. , re-power on to recover	
	OVER VOLTAGE	30 ~ 36V	59 ~ 66V
	OVER TEMPERATURE	Shut down o/p voltage, recovers automatically after temperature goes down	
ENVIRONMENT	WORKING TEMP.	-20 ~ +60°C (Refer to "Derating Curve")	
	WORKING HUMIDITY	20 ~ 90% RH non-condensing	
	STORAGE TEMP., HUMIDITY	-40 ~ +85°C, 10 ~ 95% RH non-condensing	
	TEMP. COEFFICIENT	±0.03%/°C (0 ~ 50°C)	
SAFETY & EMC (Note 4)	VIBRATION	Component:10 ~ 500Hz, 2G 10min./1cycle, 60min. each along X, Y, Z axes; Mounting: Compliance to IEC60068-2-6	
	SAFETY STANDARDS	UL508, UL60950-1, TUV EN60950-1, EAC TP TC 004 approved	
	WITHSTAND VOLTAGE	I/P-O/P:3KVAC I/P-FG:2KVAC O/P-FG:0.5KVAC	
	ISOLATION RESISTANCE	I/P-O/P, I/P-FG, O/P-FG:100M Ohms / 500VDC / 25°C / 70% RH	
	EMC EMISSION	Compliance to EN55032 (CISPR32), EN61204-3 Class B, EN61000-3-2,-3, EAC TP TC 020	
	EMC IMMUNITY	Compliance to EN61000-4-2,3,4,5,6,8,11, EN61204-3, EN61000-6-2 (EN50082-2), heavy industry level, criteria A, EAC TP TC 020	
OTHERS	MTBF	122.5K hrs min. MIL-HDBK-217F (25°C)	
	DIMENSION	276*125.2*100mm (W*H*D)	
	PACKING	3.3Kg; 4pcs/14.2Kg/1.14CUFT	
NOTE	<ol style="list-style-type: none"> 1. All parameters NOT specially mentioned are measured at 400VAC input, rated load and 25°C of ambient temperature. 2. Ripple & noise are measured at 20MHz of bandwidth by using a 12" twisted pair-wire terminated with a 0.1uf & 47uf parallel capacitor. 3. Tolerance : includes set up tolerance, line regulation and load regulation. 4. The power supply is considered a component which will be installed into a final equipment. The final equipment must be re-confirmed that it still meets EMC directives. 5. Dual phase operation(connecting L1,L3,FG)is allowed under certain derating to output load. Please refer to the derating curves for details. 6. The ambient temperature derating of 3.5°C/1000m with fanless models and of 5°C/1000m with fan models for operating altitude higher than 2000m(6500ft). 		

Mechanical Specification

Case No.934 Unit:mm

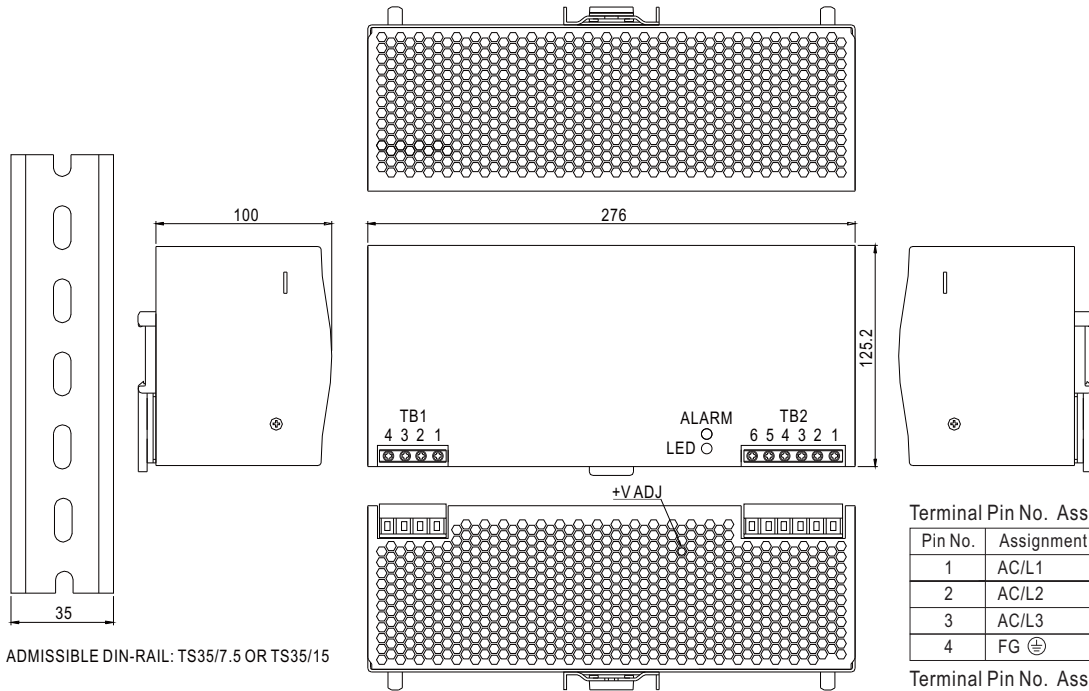

Terminal Pin No. Assignment (TB1)

Pin No.	Assignment
1	AC/L1
2	AC/L2
3	AC/L3
4	FG ⊕

Terminal Pin No. Assignment (TB2)

Pin No.	Assignment
1,2,3	DC OUTPUT +V
4,5,6	DC OUTPUT -V

Block Diagram

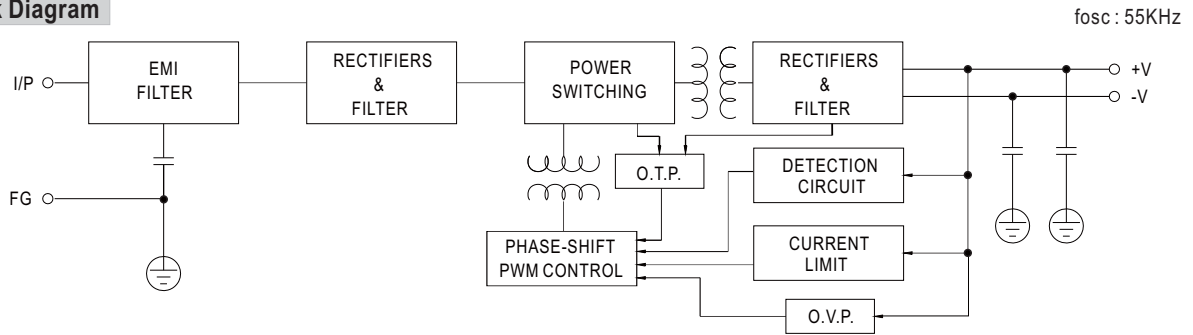

Derating Curve

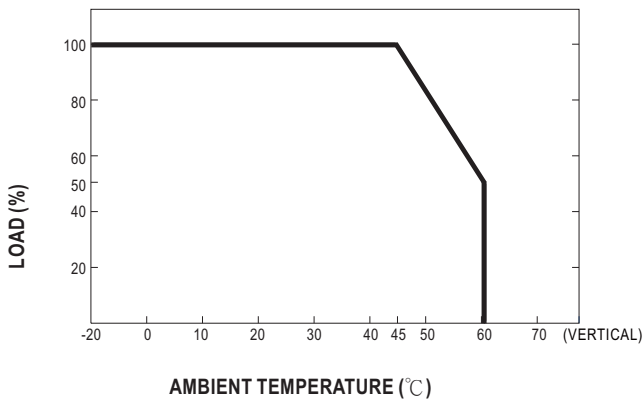

Static Characteristics

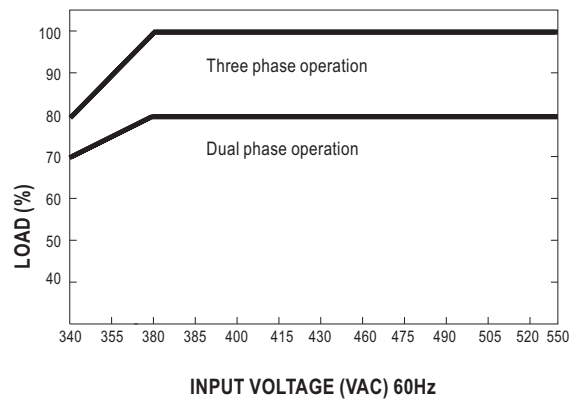

■ **Parallel Function (1+1)-Optional (Special order required)**

When in parallel operation, the minimum output load should be greater than 3% of total output load.
 (Min. load >3% rated current per unit x number of unit)

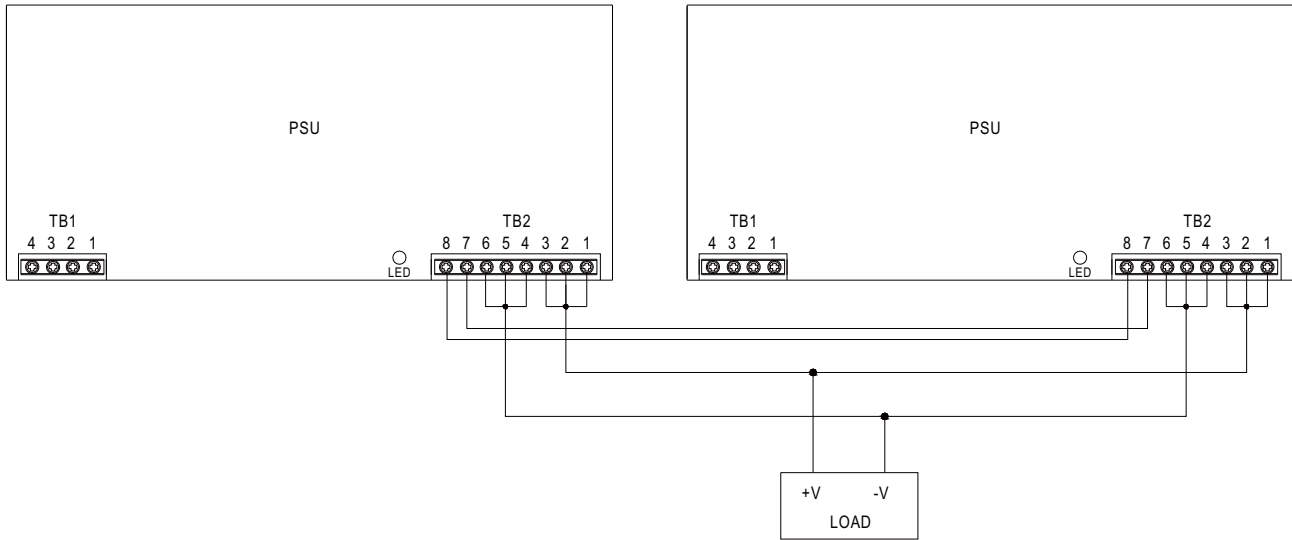

TB1 Terminal Pin No. Assignment

Pin No.	Assignment
1	AC/L1
2	AC/L2
3	AC/L3
4	FG \oplus

TB2 Terminal Pin No. Assignment

Pin No.	Assignment
1,2,3	DC OUTPUT +V
4,5,6	DC OUTPUT -V
7	GND
8	P(Current Share)

Note: Under parallel operation, if the load current is too small, only one PSU(master) would provide the power and hence the LED indicator of other PSUs may not light up.